

CanFish CF1

Live Fish Finder

User Manual

V1.0

CHASING

www.chasing.com
support@chasing-innovation.com

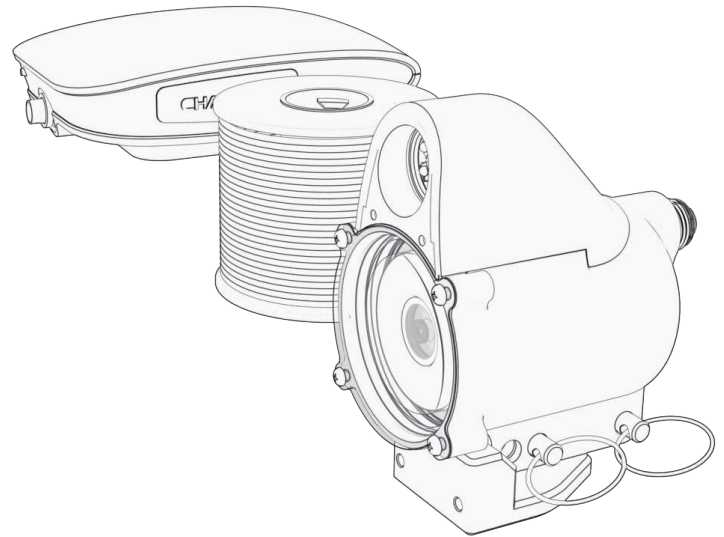

CHASING

Install and connect APP

1 Download and install CHASING GO2 App

(Applicable to iOS 9.0/Android 5.0 and other versions above)

Scan the QR code to download or visit iOS App Store/Google Play/ CHASING official website to download.



2 Booting

Push the power switch button on the repeater and push it from “0” to “1” .

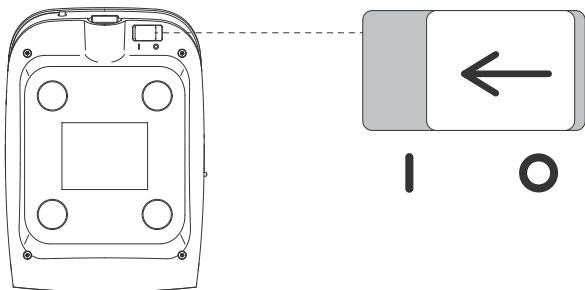

3 Connect CanFish CF1

Two ways of USB connection and Wi-Fi connection are available. USB connection is recommended first.

1. USB Connection

The provided USB cable is used to connect the repeater and the mobile phone/tablet respectively, and the USB interface with the mobile phone logo is used to connect the mobile phone/tablet.



*Note: If you cannot communicate after connection, you can turn on the OTG on your mobile phone and try to turn off WiFi and cellular traffic of your mobile phone. If you still cannot communicate normally, the mobile phone/tablet may not support the USB port function, and please use WiFi connection;

2. Wi-Fi Connection

Enter the mobile phone/tablet Wi-Fi connection interface, and ensure that the repeater has been turned on for 10 seconds. Wi-Fi name: Chasing_xxxxx/pass-word: 12345678.

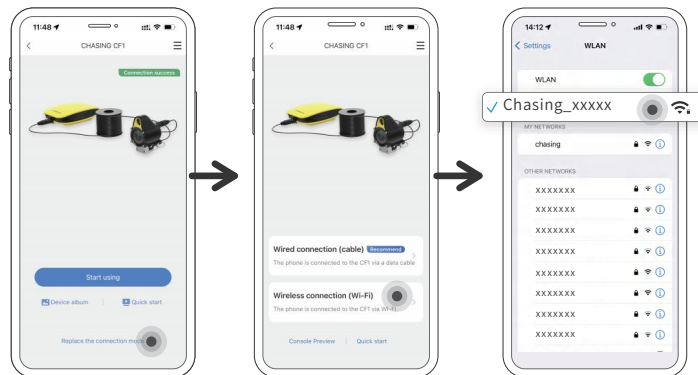

④ Turn Wi-Fi on/off or switch Wi-Fi frequency

Turn Wi-Fi on/off: Press the key on the side of the repeater for 3 seconds to turn on/off the Wi-Fi function. (*Note: After booting, the Wi-Fi function is turned on for 10 minutes by default. In case of no Wi-Fi connection, Wi-Fi shall be automatically turned off.)

Switch Wi-Fi frequency band: Short press the key on the side of the repeater to switch Wi-Fi frequency band (2.4 GHz/5GHz). Priority is given to 5GHz frequency band, and the wireless communication is of better quality.



⑤ Power bank function

After the mobile phone/tablet is connected to the repeater by USB cable, the power bank function can be turned on in the APP, and the repeater charges the mobile phone with the output power supply through the USB cable, with a power of 5V/1A. After charging, the endurance may be reduced.

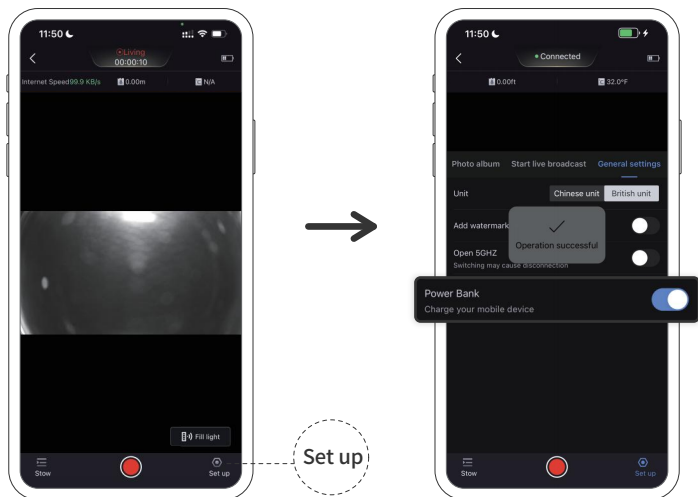

APP User's Guide

As the APP may be updated and optimized from time to time, please refer to the electronic guide pushed after each APP update;

Main Function Description

① Preview/Video

APP may preview the picture of the underwater camera in real time, and press the video button in the APP to start or stop recording.

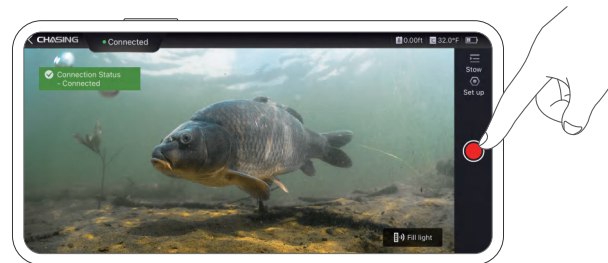

② Live

Mainstream live platforms such as Douyin, Kwai, Huya, Doyo, Inke, Bilibili, Facebook, YouTube, Tiktok and Zoom are supported in the APP.

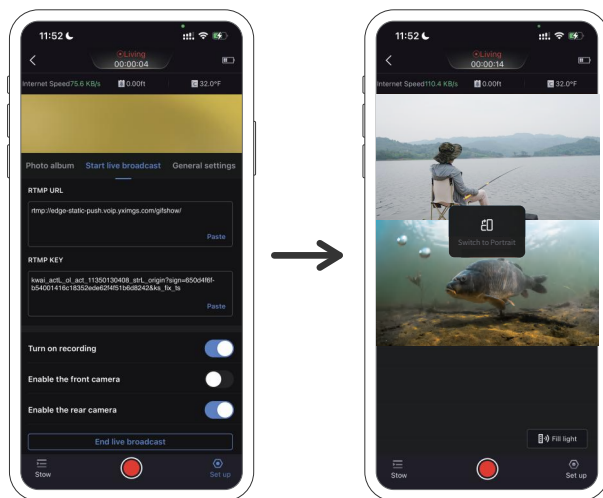

③ Infra-red Lamp (IR)

When the camera is turned-on in underwater dark light or turbid environment, it may have night vision function, and the picture may turn black and white after being turned-on.

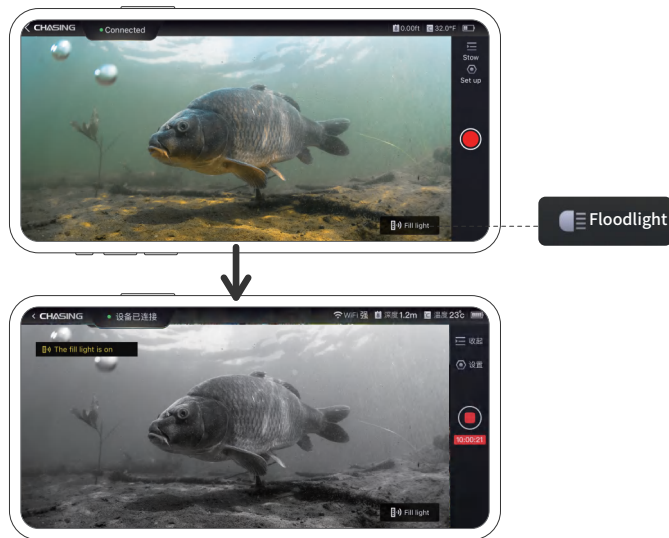

④ Storage

The video file may be stored on TF card of the repeater.

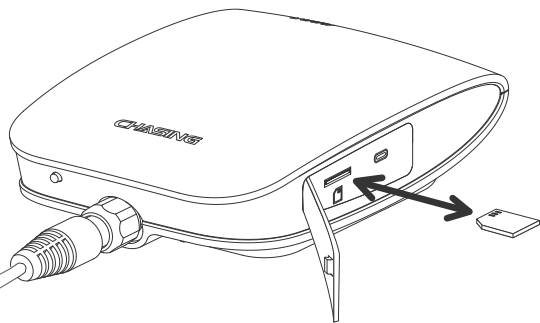

⑤ Depth/Temperature Sensor

When used at different altitudes, the depth sensor may have deviation. Please calibrate the depth/temperature sensor before launching.

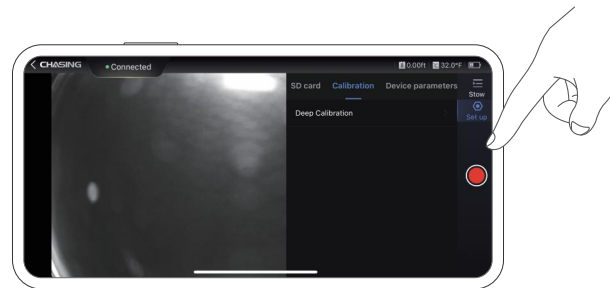

Charging Guidance

Please charge the USB interface of the repeater with a PD protocol charger. If a non-PD protocol charger is used, fast charging may be not supported, and it may take longer time to charge. The specific time is dependent on the charger power.

Safety Instructions

Precautions of Lithium Battery

1. Don't squeeze the battery pack, otherwise there may be a risk of fire and explosion;
2. Don't place the battery pack close to the fire source or heat source, otherwise there may be a risk of fire and explosion;
3. Don't discard lithium battery packs at will, otherwise it may endanger the environment;
4. Don't short-circuit the battery pack, otherwise there may be a risk of fire and explosion;
5. Don't soak the battery pack in water, otherwise there may be a risk of fire and explosion;
6. Don't store the battery pack for a long time, otherwise it may enter a power loss state. It is recommended to store 50% ~ 70% of the power and charge it every 3 months.

Waterproof Safety

1. Don't keep the waterproof camera at a depth over 30 meters, otherwise it may leak and the camera function may fail.

Recommendations of Maintenance

1. Please dry it after each use, and store it in a cool and dry place.
2. After using in seawater, please rinse the probe and cable fully with clear water, dry it and store it.

Product Parameters

Camera

Max. working depth	30m
CMOS	1/2.8", stellar level
Aperture	F2.8
Focus range	0.3m ~∞
ISO range	100-102400
Field of view	164.6°
Max. image resolution	2M (1920*1080)
Image format	JPEG
Video resolution	1080P@30fps
Max. video bit rate	4M
Video format	MP4
TF card	Pluggable (optional)

Infrared floodlight

Infrared light (IR)	7*IR beads
---------------------	------------

Charger and battery

Charger	Support fast charging of PD protocol charger 5V/9V/12V/15V/20V 1.5A
Power bank output	5V/1A
Rechargeable lithium battery	11400mAh

Other parameters

Camera waterproof rating	IP68, maximum depth of 30.5m
Waterproof communication line	30.5 m, with the maximum tension of 40kgf
Endurance	8 hours (lab test data, with battery life varying with different environments)
Weight	672g
Wi-Fi	2.4GHz, 5GHz
USB	USB-C

This User Manual is subject to update without prior notice.
The latest version is available on CHASING official website:
<https://www.chasing.com>.

APP安装与连接

① 下载安装 CHASING GO2 App

(适用于iOS 9.0/Android 5.0及以上版本)
扫描二维码下载或者访问 iOS App Store/
Google Play/潜行官网进行下载。



② 开机

推开中继器上的电源开关按钮，由“O”推到“|”。

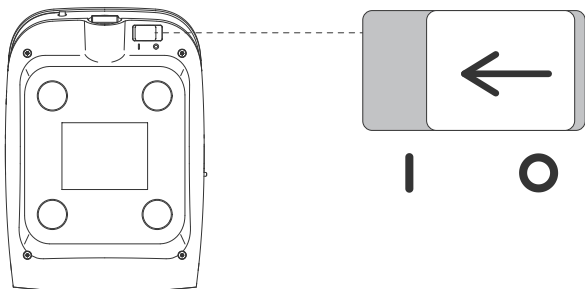

③ 连接 CanFish CF1

有USB连接和Wi-Fi连接2种方式，推荐优先使用USB连接。

1. USB连接

使用提供的USB线分别连接中继器和手机/平板，其中带有手机标识的USB接口连接手机/平板。



*注：若连接后无法通信，可打开手机OTG开关，并尝试关闭手机Wifi和蜂窝流量，如还不能正常通信，则该手机/平板可能不支持USB网卡功能，请使用Wifi连接方式；

2. Wi-Fi 连接

进入手机/平板 Wi-Fi 连接界面，中继器确保已开机10 秒，连接Wi-Fi名称：
Chasing_xxxxxx，Wi-Fi 密码：12345678。

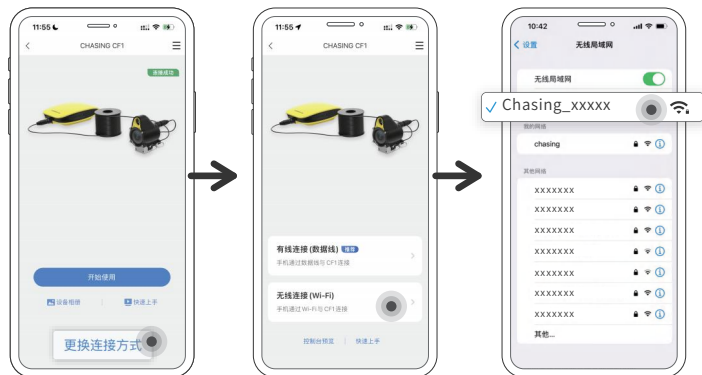

④ 开/关Wi-Fi或切换Wi-Fi频率

开/关Wi-Fi: 长按中继器侧面的按键3秒，进行Wi-Fi功能的开、关切换。

*注：开机后，Wi-Fi功能默认打开10分钟，若无Wi-Fi连接建立，则会自动关闭Wi-Fi。

切换Wi-Fi频段: 短按一下中继器侧面的按键，可进行Wifi频段切换（2.4 GHz/5GHz），建议优先使用5GHz频段，无线通信质量更佳。

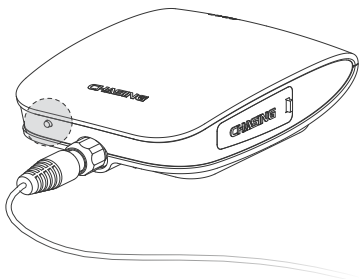

⑤ 充电宝功能

USB线连接手机/平板中继器后，可在APP内打开充电宝功能开关，中继器将输出电源通过USB线给手机充电，功率5V/1A，进行充电后，续航能力将会降低。



APP 使用指南

由于APP会不时更新优化，请以每次APP更新后推送的电子使用指南为准；

主要功能说明

① 预览/录像

APP将实时预览水下相机的画面，按下APP内录像按钮即可开始或停止录像。

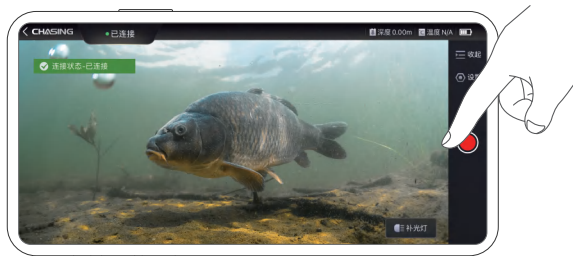

② 直播

APP内支持抖音、快手、虎牙、斗鱼、映客、哔哩哔哩、Face book、YouTube、Tiktok、Zoom 等主流直播平台。

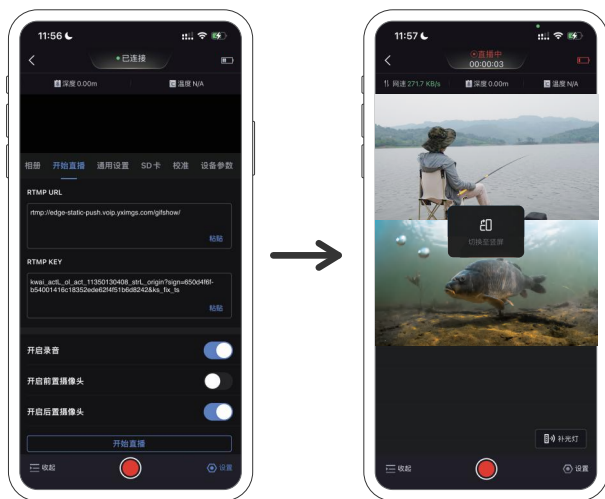

③ 夜视红外灯 (IR)

在水下暗光或浑浊环境开启后可让相机具备夜视功能，开启后画面将变黑白。

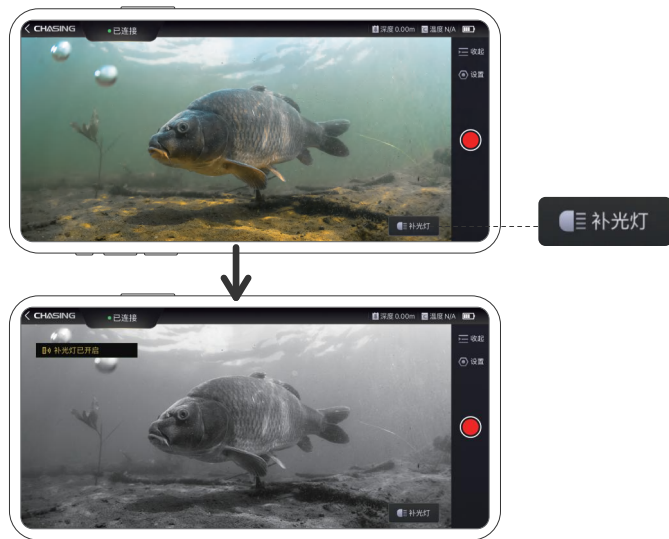

④ 存储

录像视频文件将被存储在中继器的TF卡上。

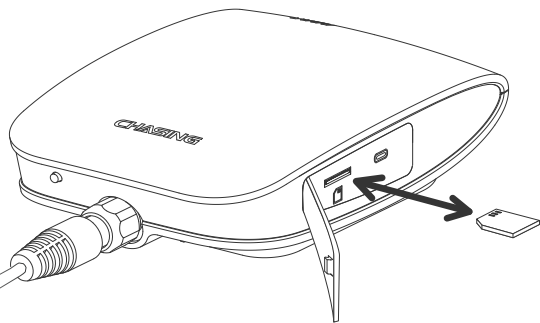

⑤ 深度/温度传感器

在不同海拔高度使用时，深度传感器会存在偏差，请下水前校准一下深度/温度传感器。



充电指导

请使用PD协议充电器给中继器USB接口进行充电，如果使用非PD协议充电器，则不支持快充，充电时间将会变慢，具体时间依据充电器功率确定。

安全事项

锂电池注意事项

1. 禁止挤压电池包，否则有起火爆炸风险；
2. 禁止电池包靠近火源或热源，否则有起火爆炸风险；
3. 禁止随意丢弃锂电池包，否则会危害环境；
4. 禁止短路电池包，否则有起火爆炸风险；
5. 禁止电池包泡水，否则有起火爆炸风险；
6. 禁止长期存放电池包，否则可能会进入亏电状态，建议50%~70%电量存储，每隔3个月进行充电一次。

防水安全

1. 禁止将防水相机处于比30米更深的深度，否则可能会漏水，相机功能失效。

保养须知

1. 每次使用完毕后请擦干，收纳好放置于阴凉干燥处。
2. 在海水中使用完毕后，用清水对探头及线缆进行充分冲洗，擦干后收纳。

产品参数

相机

最大工作深度	30m
CMOS	1/2.8英寸, 星光级
光圈	F2.8
焦点范围	0.3m ~∞
ISO范围	100-102400
视场角	164.6°
照片最大分辨率	200万 (1920*1080)
照片格式	JPEG
视频分辨率	1080P@30fps
视频最大码流	4M
视频格式	MP4
TF卡	可插拔 (非标配)

红外补光灯

IR红外光	7*IR红外光灯珠
-------	-----------

充电器及电池

充电器	支持PD协议充电器快充 5V/9V/12V/15V/20V 1.5A
充电宝输出	5V/1A
可充电锂电池	11400mAh

其他参数

相机防水等级	IP68,最大深度30.5m
防水通信线	30.5m, 最大拉力40kgf
续航	8小时 (实验室测试数据, 不同环境下续航有一定差异)
重量	672g
Wi-Fi	2.4GHz, 5GHz
USB	USB-C

本用户手册如有更新, 恕不另行通知。

您可以进入潜行官网查询最新版本:<https://www.chasing.com>